

GP Batteries

Data Sheet

Model No.: CR1/3N

Description : Lithium Battery
 Chemical system : Lithium Manganese Dioxide
 Nominal voltage : 3 Volts
 Nominal capacity : 160mAh
 Dimensions : $\varnothing 11.6 \times 10.8\text{mm}$
 Shelf life : 5 years at room temperature
 Average weight : 2.3 grams
 Applications : watch, calculator, camera
 and memory back up.

Discharge Characteristics of CR1/3N

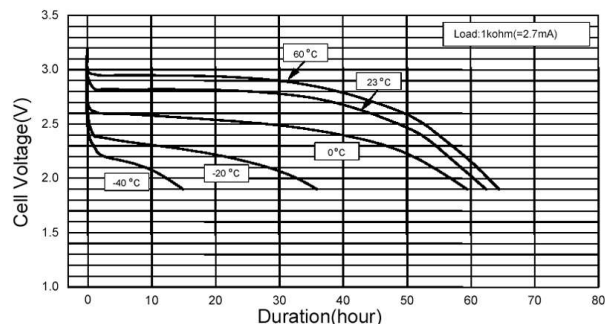

Discharge Characteristics of CR1/3N

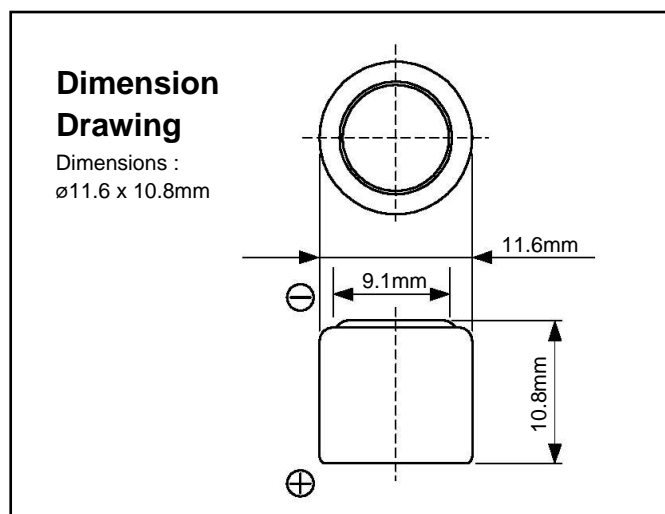
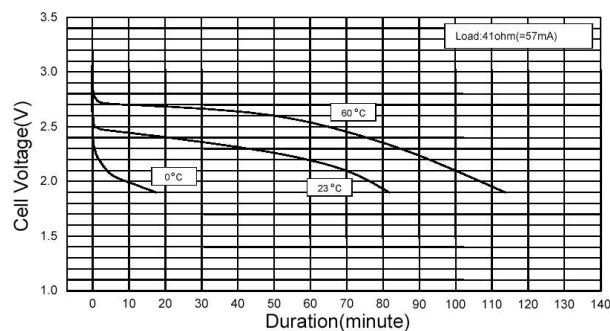

Discharge Characteristics of CR1/3N

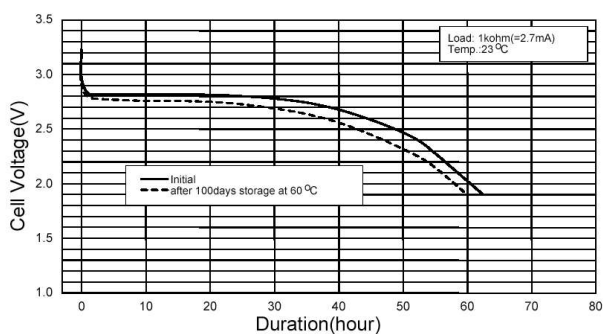

Discharge Load vs. Capacity of CR1/3N

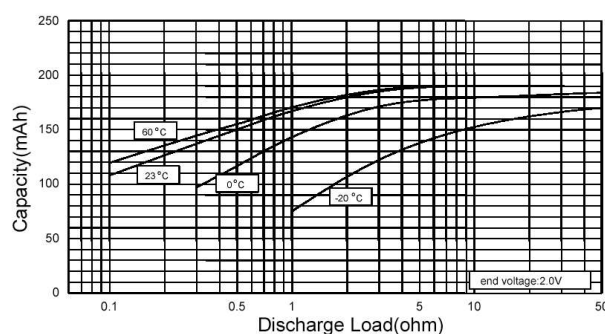

Cross References:

SANYO	Duracell	Energizer
CR-1/3N	DL1/3N	2L76