

Description : Flat Lithium Battery

Chemical System : Lithium Manganese Dioxide

Nominal Voltage : 3.0 V

Nominal Capacity : 50mAh(Load Resistance: 30k Ω , Cutoff Voltage:2.0V at 20 \pm 2 $^{\circ}$ C)

Refer to IEC60068-1 5.3, it is acceptable if the average data \geq above and no more than one battery less than 80% in total 9 pcs tested sample.

Maximum Pulse Discharge Current : 8mA

Dimensions : Φ 16.0 *1.6 mm

Shelf Life : 1 year at room temperature

Weight : 1.1 grams

Application : Computers, Calculators, Meters, Radios

Typical Discharge Characteristics On Load

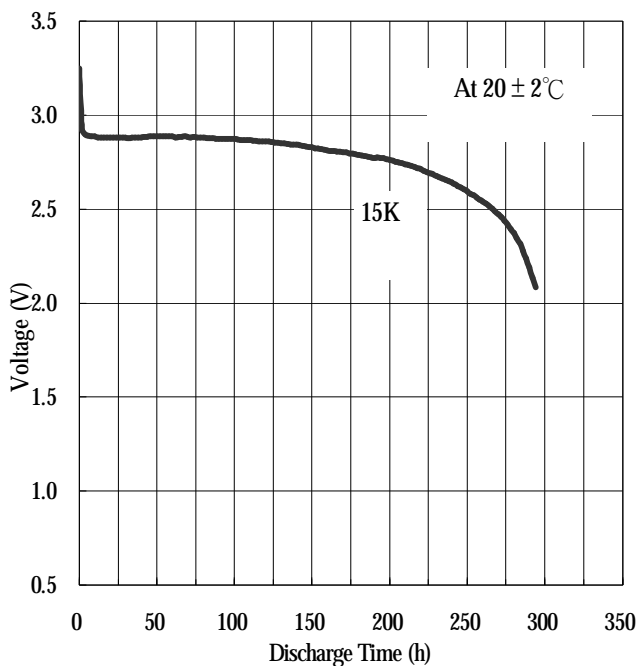

Model No.: **GPCR1616E**

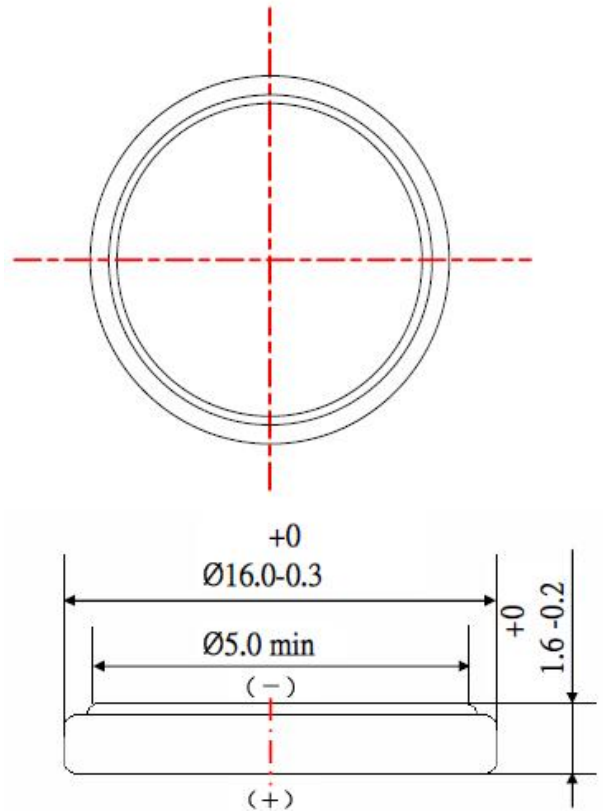

Unit : mm

Note:

- 1) No added Mercury / 99.9999% Mercury Free
- 2) No added Lead / 99.999% Lead Free
- 3) No added Cadmium / 99.9999% Cadmium Free
- 4) No added PFOS (Perfluorooctane sulfonates)
- 5) This battery complies with ANSI C18, IEC 60086, and EEC Directive 2006/66/EC
- 6) Batteries are NOT subject to European RoHS regulations.
- 7) Primary Batteries (non-Rechargeable) are not subject to China RoHS regulations.
- 8) Store lithium coin cells out of sight and reach of young children.
- 9) Make certain the battery compartment of every household product is securely closed and child-resistant (for example screwed shut), and/or the product is stored out of the reach of young children.

In applications where the battery is exposed to temperatures above 70 $^{\circ}$ C, please contact GP for consultancy.

The information (subject to change without prior notice) contained in this document is for reference only and should not be used as a basis for product guarantee or warranty. For applications other than those described here, please consult your nearest GP Sales and Marketing Office or Distributors.